



BRAND
HYDRAULICS Co.

Made in the Heartland of America
Serving the World

Engineering & Manufacturing Solutions

EFC

Electronically Adjustable Proportional
Pressure Compensated Flow Control

Specifications:

- See flow chart for capacity.
- 3000 psi (207 bar) rating.
- Weighs 8-1/2 lbs. (3.9 kg).
- Standard Port size #12SAE (1-1/16 – 12).
- 10-Micron Filtration Recommended.
- Pulse Frequency (90 to 115 hz).
- Coil

-12 VDC standard	(24 VDC).
-9.6 ohms	(48 ohms).
-15 watts	(15 watts).
-1.0 amp max	(0.5 amp max.).



PEFC12-10-12

PEFC12-15-12R22

- Response Time
 - 0.035" Standard dash pot (375 ms).
 - 0.020" Dash pot (900 ms).
 - 0.093 Dash pot (175 ms to 350 ms depending on flow).
- Spool leakage (3.05 in³/min. @ 1000 psi ((50 ml/min. @ 68.9 bar) on EX port).



ISO 9001:2008 WITH DESIGN
Certificate #02.002.1



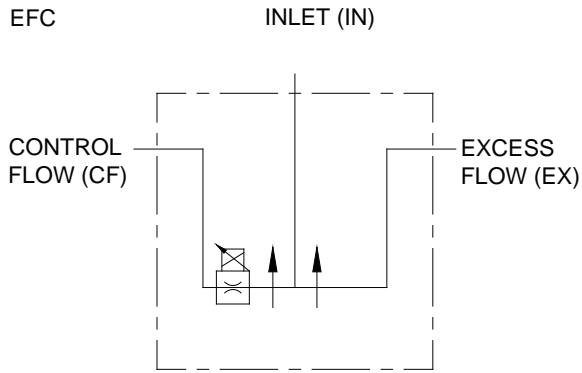

PEFC12-10-12

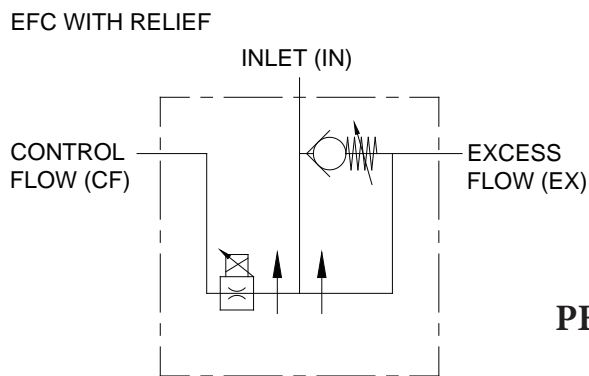

PEFC12-15-12R22

**MATERIALS:**

- Ductile Cast Iron Body
- Heat Treated Steel Spools
- Buna N O'Rings
- Heat Treated Free Reverse Check Seat

FEATURES:

- DIAMOND HONED SPOOL BORE provides consistent spool fit with low leakage.
- O'RING PORTS to eliminate leakage.
- EVERY EFC IS TESTED for shutoff, linearity, max. flow, crack open and pressure compensation.
- STANDARD 3-PORT allows for pressure compensated flow out of the CF and EX ports.
- MANUAL OVERRIDE when electrical power is lost.
- OPTIONAL 2-PORT allows for pressure compensated flow out of CF port.
- OPTIONAL FREE REVERSE FLOW allows fluid to move from the CF port to the inlet.
- OPTIONAL HIGH LIFT RELIEF.

EFC – GENERAL INFORMATION

The Brand, electronically adjustable proportional pressure compensated flow control is an electronically controlled version of the original FC51 style flow control valve. The EFC performance as a flow control is very similar to the FC51 because they both use the same spring and compensator spool. Thus, the control flow port (CF) and the excess flow port (EX) remain usable and pressure compensated.

The main advantage of the EFC over the FC51 is that the flow can be adjusted proportionally with a solenoid instead of manually. As the current to the solenoid increases the variable orifice moves proportionally similar to positioning the rotary side lever on the manual FC's. The solenoid is connected to our EC – series controls which can be sold with the EFC. We also give the choice of a dashpot size, which allows the customer to select a valve that responds to the control box at different rates. Other options are 2-port, free reverse flow and high lift ball spring relief.

2-PORT- The 2-port (2P) option is a modified version of the standard 3-port EFC. This option lets the customer use the control flow port while the excess port is plugged. A special compensator spool was designed to eliminate hunting that can occur between pressure compensated valves and pumps. To use the EFC 2-port a pressure compensated pump is required. The 2-port can be converted to a 3-port (by removing the EX plug), but it will not have the same characteristics as the standard 3-port. (See chart on next page for 2-port EFC)

FREE REVERSE FLOW- The free reverse flow option was designed to be used primarily where cylinders and motors are needed to go in reverse. The flow can only go in reverse from controlled flow (CF) to the inlet (IN). Flow is not metered when it goes in reverse. The steel ball seat inside the compensator spool is heat treated to assure a long life.

HIGH LIFT BALL SPRING RELIEF - The high lift ball spring relief (R) reduces plumbing and provides relief protection. Once the pressure on the inlet port increases above the relief setting the relief valve opens and diverts flow to the EX port while maintaining pressure on the IN port. The EX port must be plumbed back to tank for this relief to work. This relief does not chatter and the cracking pressure from low to high flow is virtually the same. The relief is easily adjustable by simply loosening the lock nut and turning the adjusting fitting. (See relief chart on next page)

EFC – EXAMPLES OF COMMON MODEL CODES:

- EFC12-10-12**.....10 gpm (37.9 lpm) 3-port with 12 volt coil
- EFC12-15-12R15**..... 15 gpm (56.8 lpm) 3-port, 12 volt coil with 1500 psi (103.4 bar) relief
- EFC12-10-122P**.....10 gpm (37.9 lpm) 2-port with 12 volt coil
- CEP1000**.....10 gpm (37.9 lpm) 3-port with EC-12-01 control

EFC – CREATING A MODEL CODE FOR EFC’S:

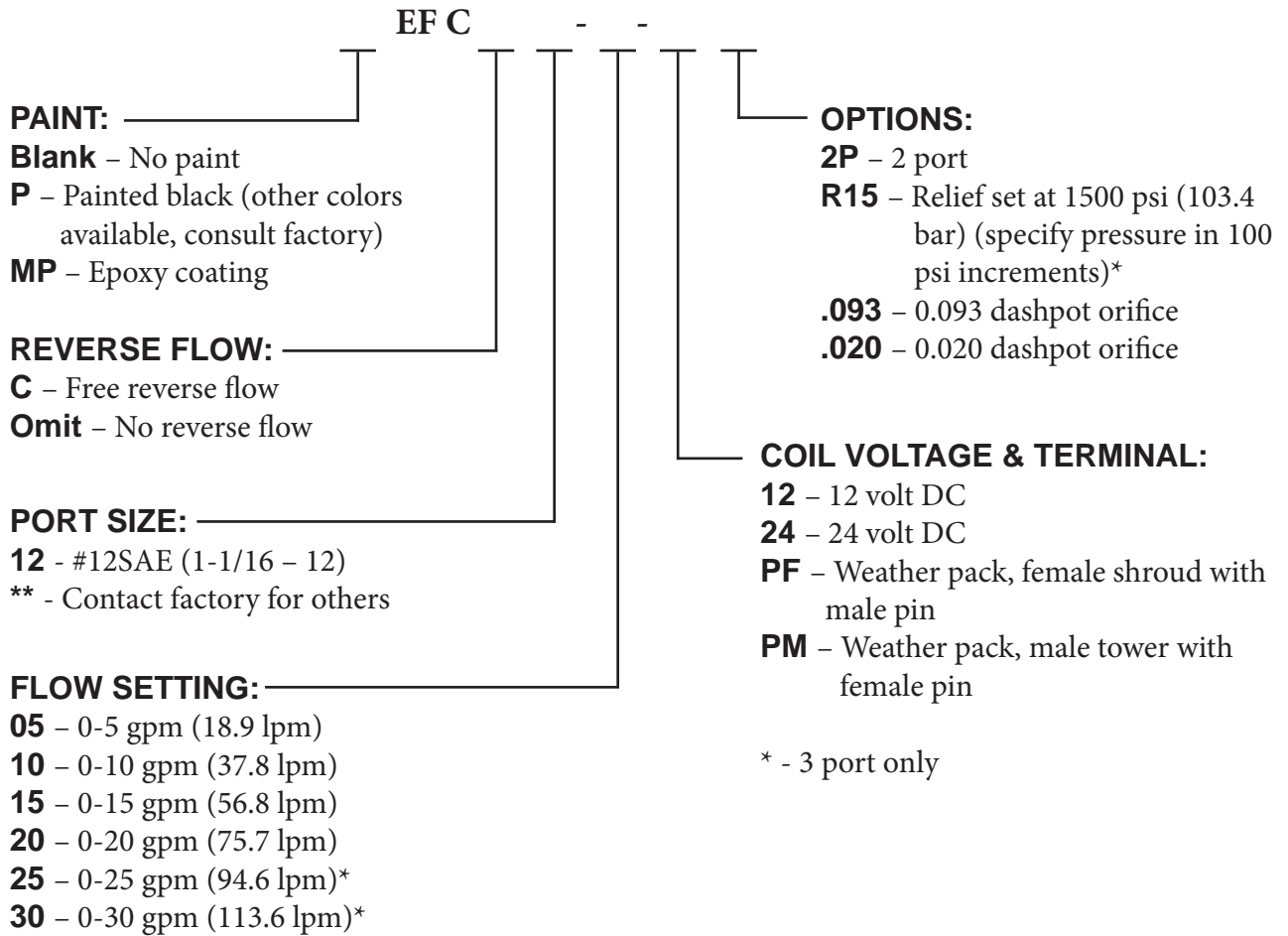

EFC - WITH ELECTRONIC CONTROL:

<p>PAINT:</p> <p>Blank - No paint</p> <p>P - Painted black (other colors available, consult factory)</p> <p>MP - Epoxy coating</p> <p>REVERSE FLOW:</p> <p>C - Free reverse flow</p> <p>Omit - No reverse flow</p> <p>CONTROLS:</p> <p>D - EC-12-02 (Dashmount)</p> <p>Omit - EC -12-01 (Weather proof box)</p>	<p>CEP</p> <p>00</p>	<p>OPTIONS:</p> <p>2P - 2 port</p> <p>R15 - Relief set at 1500 psi (103.4 bar) (specify pressure in 100 psi increments)*</p> <p>.093 - 0.093 dashpot orifice</p> <p>.020 - 0.020 dashpot orifice</p> <p>Omit - No options</p> <p>* - 3 port only</p> <p>FLOW SETTING:</p> <p>05 - 0-5 gpm (18.9 lpm)</p> <p>10 - 0-10 gpm (37.8 lpm)</p> <p>15 - 0-15 gpm (56.8 lpm)</p> <p>20 - 0-20 gpm (75.7 lpm)</p> <p>25 - 0-25 gpm (94.6 lpm)*</p> <p>30 - 0-30 gpm (113.6 lpm)*</p>
---	------------------------------------	--

EFC FLOW & SOLENOID CURRENT INFO FOR 2-PORT AND 3-PORT:

Flow vs. Solenoid for EFC 3-Port
Oil Temp = 100 deg. F w/140-147 SUS Oil

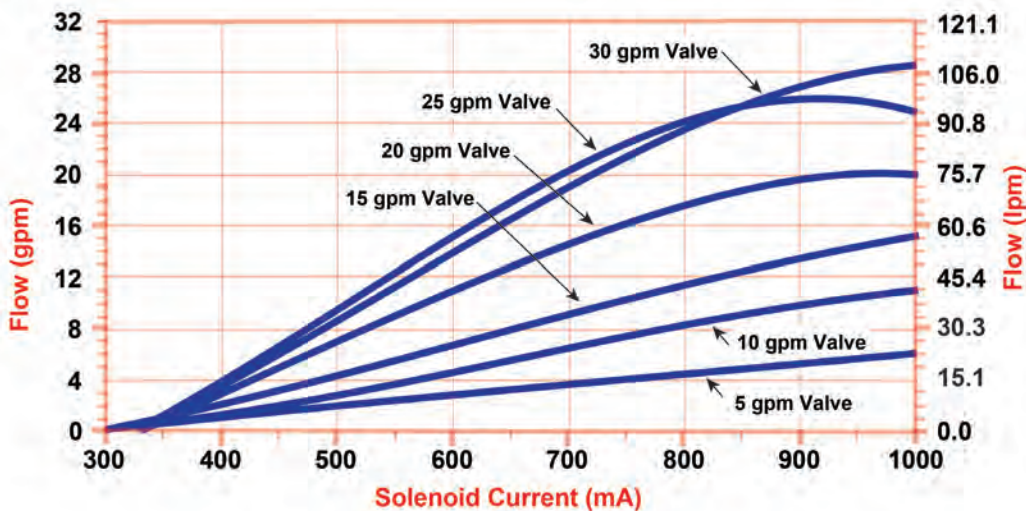

EFC FLOW & SOLENOID CURRENT INFO FOR 2-PORT AND 3-PORT:

Flow vs. Solenoid Current for EFC 2-Port

Oil Temp = 100 deg. F w/140-147 SUS Oil

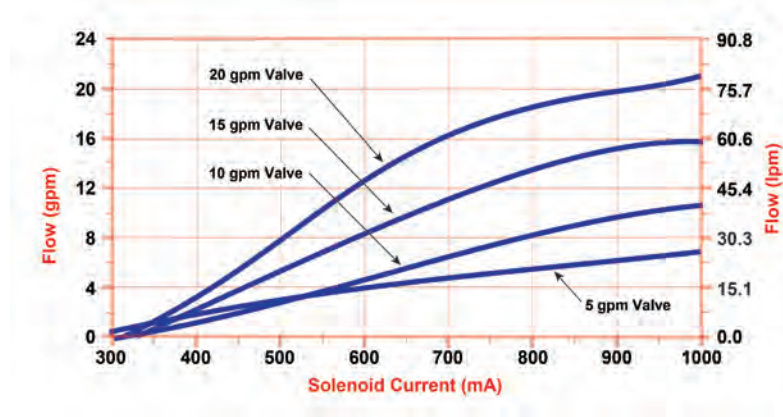

Pressure Drop vs. Flow for EFC Series

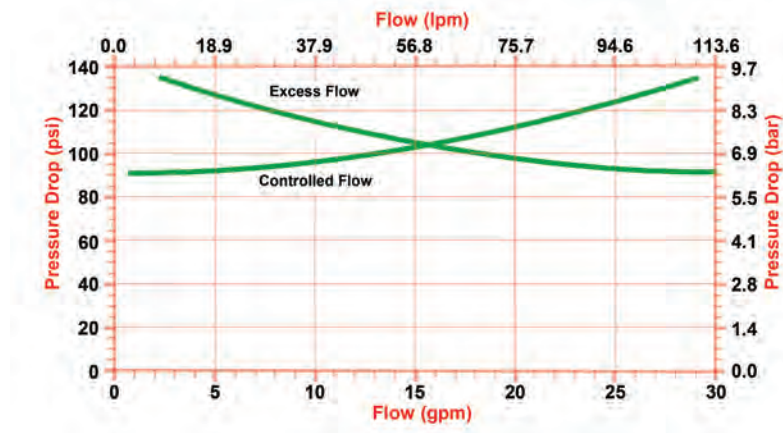

Pressure vs. Flow for EFC with Relief

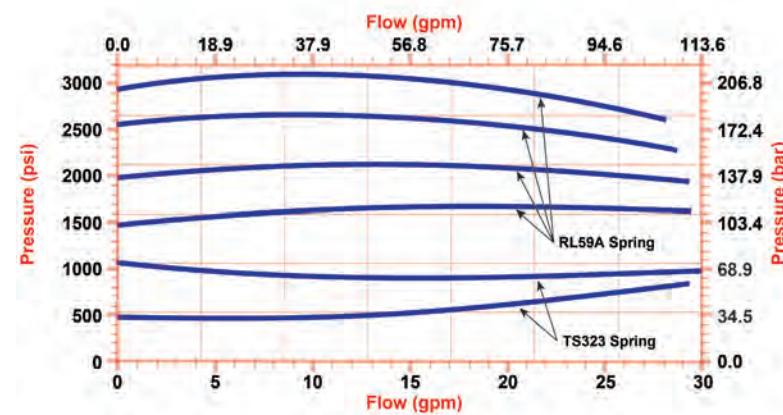

2 & 3 PORT SCHEMATIC DRAWING:

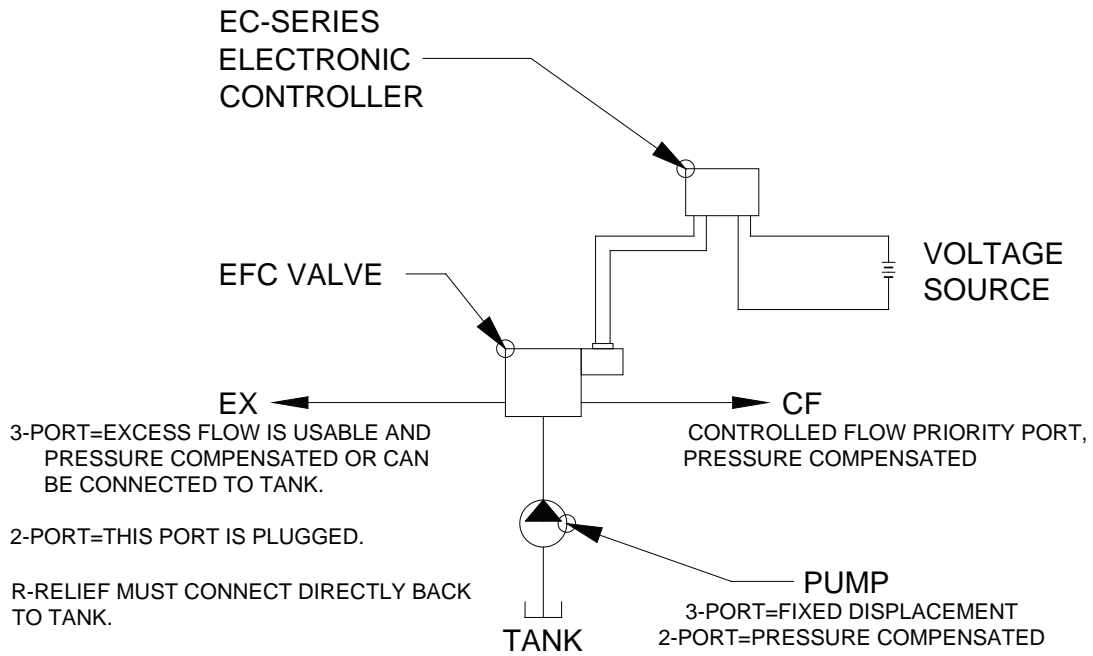

DIMENSIONAL DATA (EFC WITH RELIEF SHOWN):

